

Product Specification Sheet



OPERA-H JACKSHAFT OPERATOR

STANDARD FEATURES

• **Motor:**

60Hz high starting torque, continuous-duty, single phase capacitor start or 3 phase motor, open drip proof, protected against overload. Also available with 50Hz 220V 1 phase and 380V 3 phase motor, consult inside sales.

• **Reduction:**

First step in reduction 5L/B V-belt drive, additional steps by chain and sprockets. Input shaft is 5/8", supported by precision ball bearings. Output shaft is 1" with 1/4" keyway, supported by ball bearings. Output shaft speed: 41 rpm.

• **Clutch:**

Friction type, positioned on input shaft, easily adjustable from outside.

• **Drive:**

#50 roller chain with a 50B12 sprocket for the operator drive shaft. Door sprocket selected for a door travel of 6"/s to 12"/s.

• **Brake:**

Mechanical brake.

• **Manual Operation:**

Hoist-a-matic® self-engaging hoist (floor level engagement device is not required to operate) for manual chain operation. An electrical interlock automatically disconnects power to the motor operator when the chain hoist is engaged. Hoist on right is standard.

• **Electrical Enclosure:**

All electrical components are in a Nema 1 enclosure. Hinged electrical enclosure cover.

• **Limit System:**

Rotary-type oil-impregnated steel cams, commercial grade switches. Limit shaft is supported by self-lubricating bronze bushings for increased precision. Remains in time when there is a manual operation or after the motor has been removed.

• **Accu-cam® Feature:**

Precise and quick one-handed adjustment of the limits.

• **Corrosion Protection:**

Frame and control enclosure protected by baked on, long lasting enamel finish. Polymer control box cover. All shafts protected by yellow chromate coating.

• **Mounting:**

Wall, hood, or shelf mounted on the right or on the left of the door.

• **Shipping Weight:**

Approx. 86 Lbs - 39 Kg.

• **Warranty:**

2 Years.

Hoist-a-matic®

Self-engaging chain hoist with automatic cut-off

Accu-cam® Limit Feature

For precise and quick one-hand limit setting adjustments

Hinged Cover With Stable Opened Position

For easy access to components and wiring

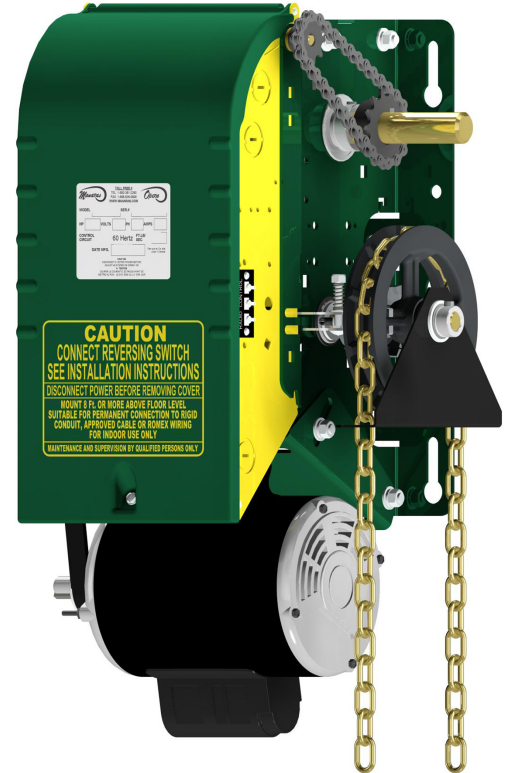

The Opera-H is a heavy-duty industrial operator designed for use on standard, high and vertical lift sectional doors or rolling doors and grilles.

The operator can be wall, hood, or shelf mounted on either side of the door. It incorporates the patented Hoist-a-matic®, a self-engaging chain hoist for manual operation, which simplifies operation and installation.

The operator is available with the new Electronic Control Board (BOARD 070) with or without the option of electrical control for MONITORED external entrapment protection devices (UL325-2010 compliant).



When you think
Commercial Door OPERATORS,
just think OPERA.

800-361-2260
info@manaras.com
www.manaras.com

CONTROL OPTIONS

• ECB Units (BOARD 070):

24Vdc relaying circuit with a 40VA class II transformer, non-volatile memory. Features available: 1.5s delay on reverse, programmable maximum run timer, mid-stop, timer to close (suspension possible from floor level), independent input loop terminal, advance close system, test buttons, reverse wiring detection and door lock sensor. Operating mode selectable on site: C2, B2, D1, E2, T or TS.

• "M" Version:

Provides the monitoring of Primary External Entrapment Protection Devices. Includes monitored photo cells (PHOTO 062 standard). In this mode, Ancillary Entrapment Protection Devices (optional) may be used to supplement primary entrapment protection, such as non-monitored photo cells, 2-wire non-monitored sensing edges and pneumatic sensing edges. Certifications: CSA C22.2-247.92 and UL325.

• "E" Version:

No monitoring function. Certifications: CSA C22.2-247.92 and UL325 5th Ed. PRIOR to August 2010 revision.

• Contactor Units:

24VAC control circuit, 40VA class II transformer, fuse protected on output, heavy-duty across-the-line linear reversing contactor with mechanical interlock.

• B2/C2 Units:

C2 wiring is standard. B2 can be set very easily by moving one wire. Available options: delay on reverse, timer to close, double limits, etc... Certifications: CSA C22.2-247.92 and UL325 5th Ed. PRIOR to August 2010 revision.

MAIN OPTIONS

• Control Accessories:

Angled terminal strip allows for the connection of 3-button stations (one supplied with the operator), non-monitored sensing edges, non-monitored photo cells, one push-button radio control (external strip), ceiling pull switches, key switches, loop detectors, external interlocks, plug-in radio card and universal auxiliary output module. 2A fuse protected 24VAC output is available for accessory power supply. NEMA 4/12 or NEMA 4X protected monitored photo cells upgrade available.

• Environmental Modifications:

NEMA 4/12 and NEMA 4X enclosures. For NEMA 7/9, consult inside sales.

• Mechanical Accessories:

Wall or hood mounting bracket, chain spreader, etc...consult inside sales.

• Mechanical Modifications:

Left hand chain hoist, electrically activated drum-band type solenoid brake, cast iron flanged pillow block bearings on output shaft, limit shaft speed-up, etc...consult inside sales.

DIMENSIONS

Clearance: Side room required 15" (380 mm)

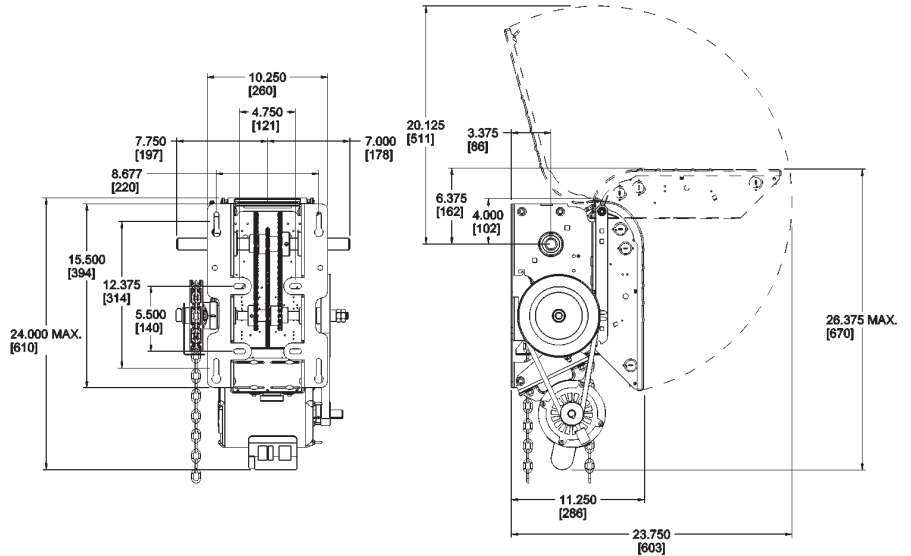

MOTOR SELECTION

Maximum Size of Door in Square Feet

Horse Power	Rolling Doors					Sectional Doors				
	Insulated Steel	16 ga. Steel	Steel Grilles 20 ga. Steel	Alu. Door 22 ga. Steel	Alu. Grilles 24 ga. Steel	Steel 18 ga. ins.	Steel 18 ga. 20 ga. ins.	Wood Steel 20 ga. 22 & 24 ga. ins.	Aluminum Steel 22 & 24 ga.	Fiber Glass
1/2	157	236	260	319	358	196	245	314	343	392
3/4	206	294	358	451	515	270	319	441	490	549
1	255	358	446	574	613	294	392	490	564	613

General Guideline

OPERATOR RANGE

Current Consumption (Amp.)

Horse Power	120V 1 Ph	240V 1Ph	208/240V 3 Ph	480V 3 Ph	600V 3 Ph
1/2	8.0	4.0	2.1	1.0	0.8
3/4	11.2	5.6	3.2	1.5	1.2
1	13.6	6.8	4.4	2.1	1.6

General Guideline

